

S3M090065LH



TriQSiC™ 650V Silicon Carbide Power MOSFET G3

N C E

Features

- H
- H
- T
- H, R HS

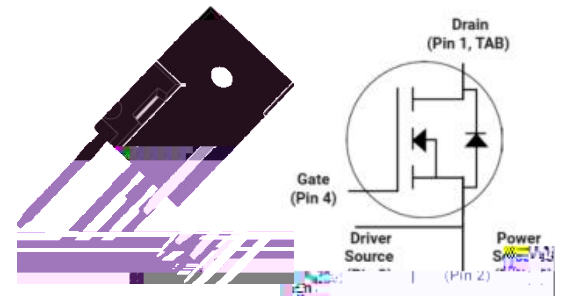

Benefits

- C
- E
- R
- I
- I

TO-247-4L



Applications

- E
- P
- S
- S

Table 1 Key performance and package parameters

| Type | V _{DS} | I _{DS} (T _C = 25 °C, R _{θ(j-c)}) | R _{DS(on), typ} (V _{GS} = 15 V, I _D = 12A, T _J = 25 °C) | T _{J,max} | Marking | Package |
|-------------|-----------------|---|--|--------------------|-------------|-----------|
| S3M090065LH | 650 | 35A | 90 | 175 | S3M090065LH | TO-247-4L |

Table of contents

Table of contents

| | |
|--|----|
| Features | 1 |
| Benefits | 1 |
| Applications | 1 |
| Table of contents | 2 |
| 1 Maximum ratings | 3 |
| 2 Thermal characteristics | 3 |
| 3 Electrical characteristics | 4 |
| 3.1 Static characteristics | 4 |
| 3.2 Dynamic characteristics | 4 |
| 3.3 Switching characteristics | 5 |
| 4 Electrical characteristic diagrams | 6 |
| 5 Package drawing (TO-247-4L-C) | 11 |
| 6 Test conditions | 12 |
| Revision history | 13 |
| Attention | 13 |

1 Maximum ratings

Table 2 Maximum rating ($T = 25\text{ C}$)

| Symbol | Parameter | Value | Unit | Test Conditions | Note |
|-------------------|-----------|------------|------|--|-------|
| V_{DS} | D | 650 | | $V_{GS} = 0$, $I_D = 100\text{ A}$ | |
| V_{GS} | G | -8 / +19 | | A | N 1 |
| V_{GS} | G | -4 0 / +15 | | R | |
| I_D | C | 35 | A | $V_{GS} = 15$, $T_C = 25\text{ C}$ | F .19 |
| | | 25 | | $V_{GS} = 15$, $T_C = 100\text{ C}$ | |
| $I_D(\text{---})$ | P | 86 | A | $P = 100$, T_J | F .22 |
| P_D | P | 120 | | $T_C = 25\text{ C}$, $T_J = 175\text{ C}$ | F .20 |
| T_J, T | O J | -55 +175 | C | | |
| T_L | S | 260 | C | 1.6 (0.063) 10 | |
| T_M | M | 1 | N | M3 6-32 | |
| | | 8.8 | | | |

N 1 MOSFET B D $V_{GS} = -4 / +19$

2 Thermal characteristics

Table 3 Thermal characteristics

| Symbol | Parameter | Min. | Typ. | Max. | Unit | Test Conditions | Note |
|-----------|-----------|------|------|------|------|-----------------|-------|
| $R_{(-)}$ | T | - | 1 | 1.25 | C/ | - | F .21 |

3 Electrical characteristics

3.1 Static characteristics

Table 4 Static characteristics (T = 25 C)

| Symbol | Parameter | Min. | Typ. | Max. | Unit | Test Conditions | Note |
|--------------|-----------|------|------|------|------|---|-------|
| $(BR)_{DSS}$ | D - | 650 | - | - | | $V_{GS} = 0$, $I_D = 100$ A | |
| $V_{GS()}$ | G | 2.7 | 3.5 | 4.2 | | $V_{DS} = V_{GS}$, $I_D = 3.5$ A | |
| I_{DSS} | | - | 2.7 | - | | $V_{DS} = V_{GS}$, $I_D = 3.5$ A, $T_J = 175$ C | F .11 |
| I_{GSS} | G | - | 1 | 10 | A | $V_{DS} = 650$, $V_{GS} = 0$ | |
| $R_{DS()}$ | C - | - | - | 100 | A | $V_{GS} = 15$, $V_{DS} = 0$ | |
| | | - | 90 | 120 | | | |

θ_{JC}
 θ_{JA}
 θ_{JL}
 $\theta_{JL} = 3$

SAP

S3M090065LH



650V SiC Power MOSFET

| | | | | | | | |
|---|---|---|----|---|---|---|-------|
| Q | G | - | 10 | - | C | $V_{DS} = 400$, $V_{GS} = -4/+15$ $I_D = 12A$ | F .12 |
| Q | G | - | 7 | - | | | |
| Q | G | - | 21 | - | | | |

3.3 Switching characteristics

Table 6 Dynamic characteristics($T = 25\text{ C}$)

| Symbol | Parameter | Min. | Typ. | Max. | Unit | Test Conditions | Note |
|--------|-----------|------|------|------|------|--|-------|
| E | T | - | 48 | - | J | $V_{DS} = 400$, $V_{GS} = -4/+15$ $I_D = 12A, R = 2.5$, $L = 120\text{ H}$ | F .26 |
| E | T | - | 12 | - | | | |
| | T | - | 10 | - | | | |
| | R | - | 11 | - | | | F .27 |
| | T | - | 14 | - | | | |
| | F | - | 8 | - | | | |

E

W!

Lλ

L6

10

Dλu sg

4 Electrical characteristic diagrams

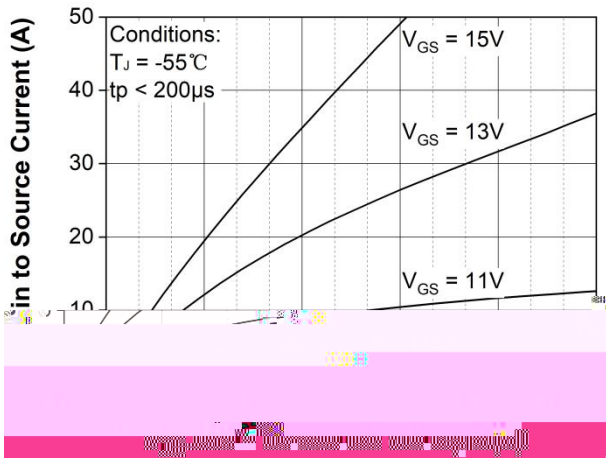

F 1. O $T_j = -55\text{ C}$

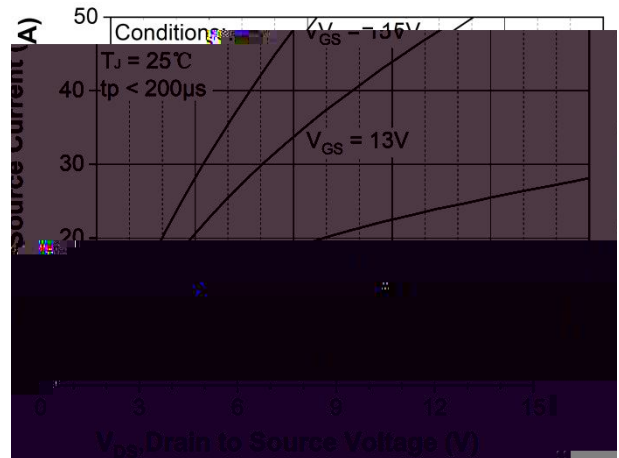

F 2. O $T_j = 25\text{ C}$

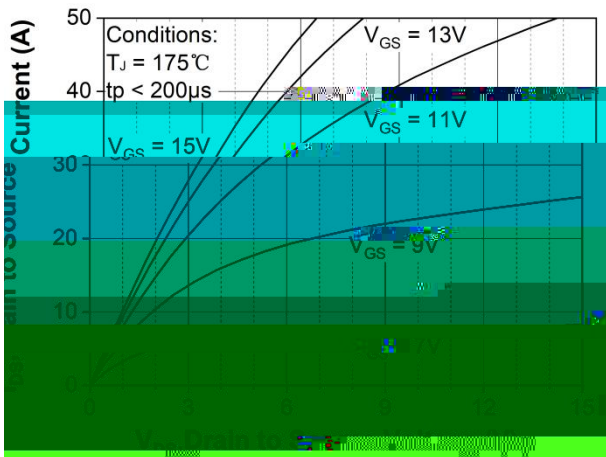

F 3. O $T_j = 175\text{ C}$

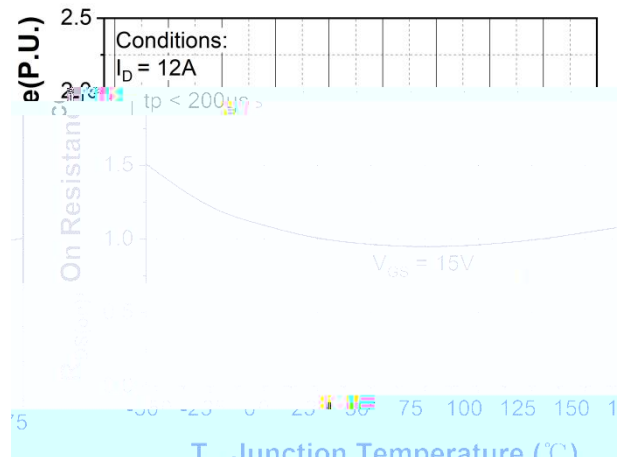

F 4. N



F 5. O -

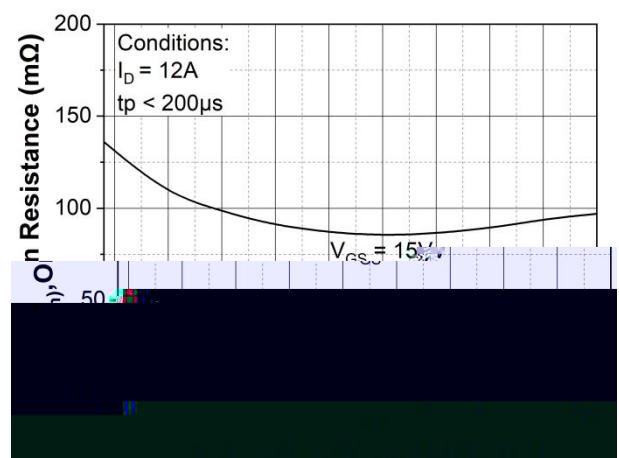

F 6. O -

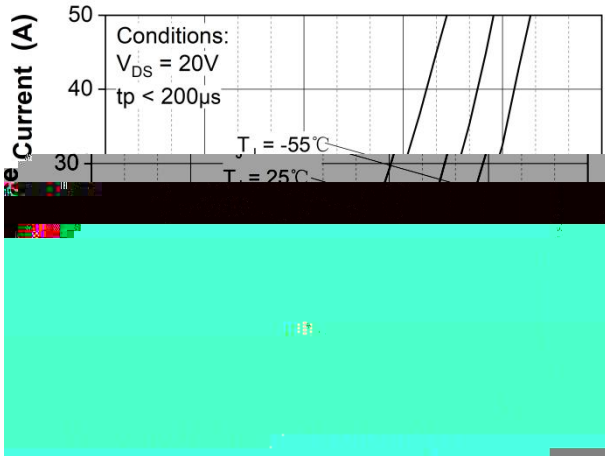

F 7.T

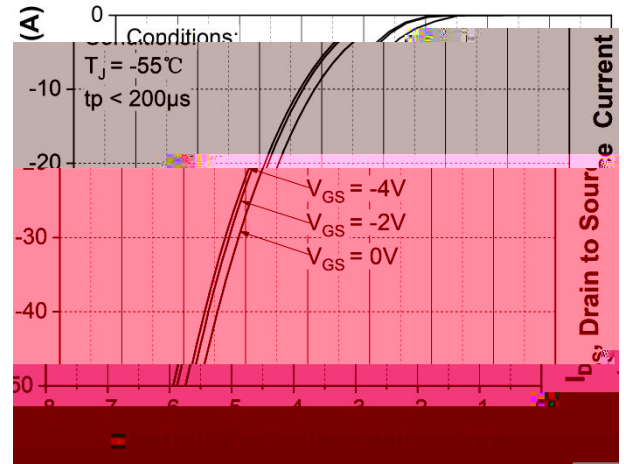

F 8.B $T_j = -55^\circ C$

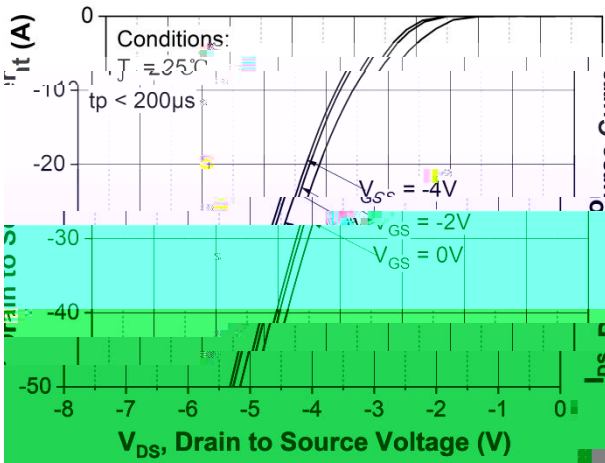

F 9.B $T_j = 25^\circ C$

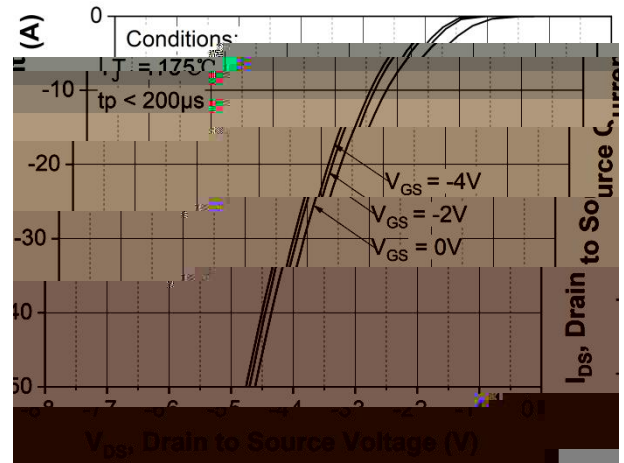

F 10.B $T_j = 175^\circ C$

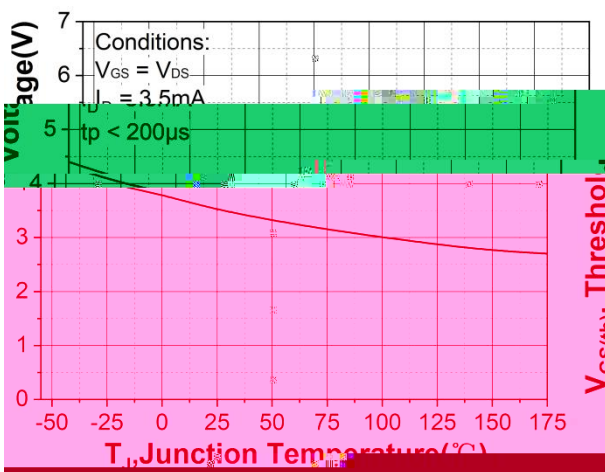

F 11.T

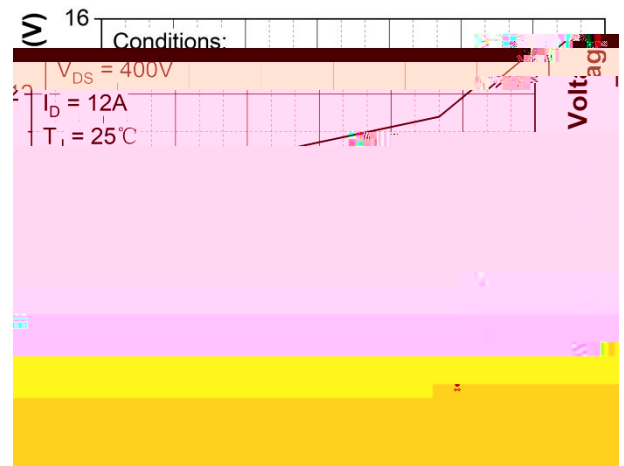

F 12.G

S3M090065LH

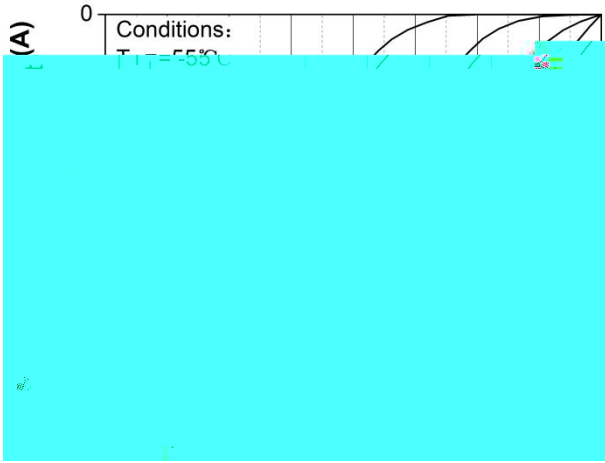

F 13.3 $T_J = -55\text{ C}$

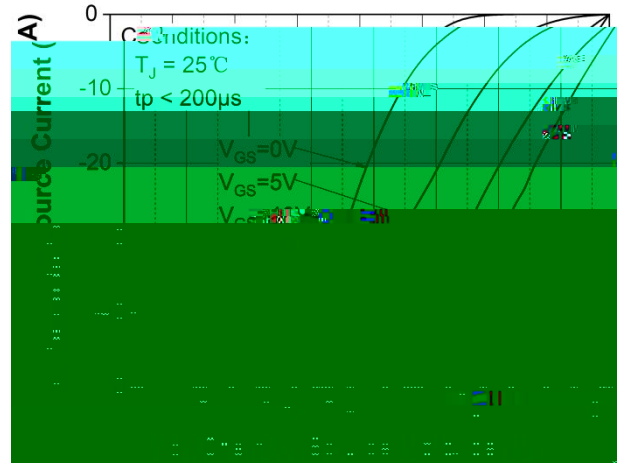

F 14.3 $T_J = 25\text{ C}$

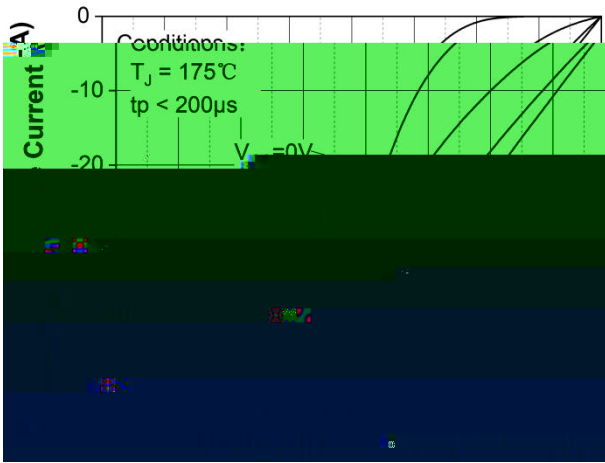

F 15.3 $T_J = 175\text{ C}$

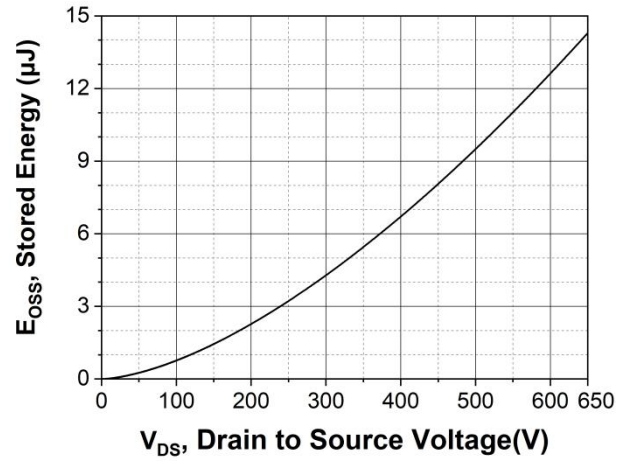

F 16.0

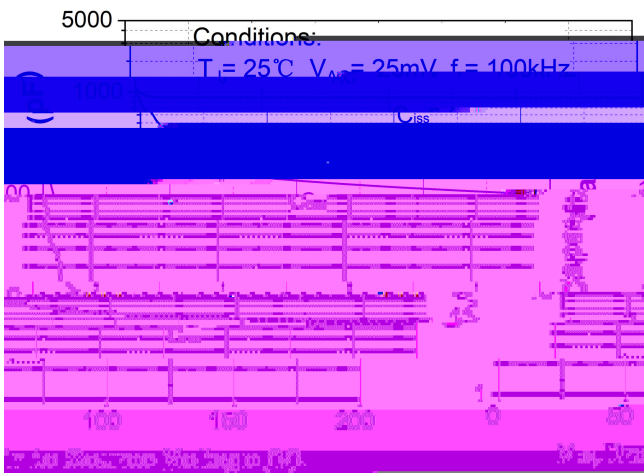

F 17.C - (0 - 200)

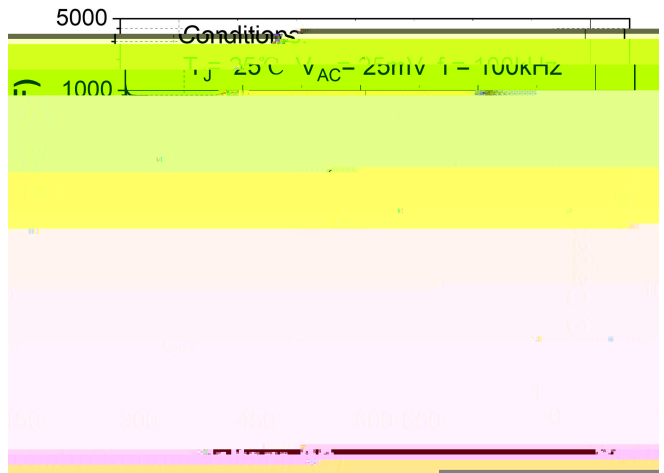

F 18.C - (0 - 650)

D

01 01

S3M090065LH

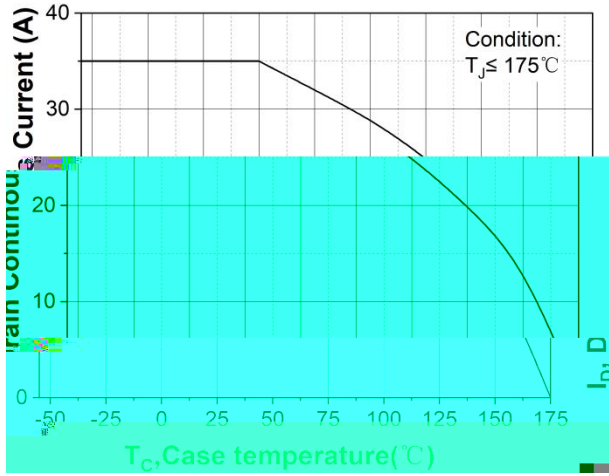

F 19. C

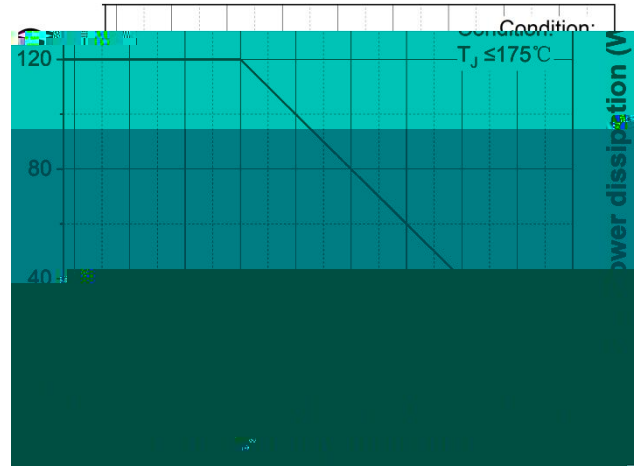

F 20. M

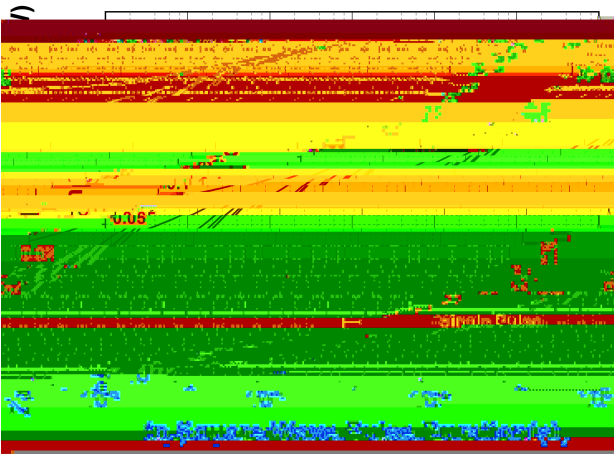

F 21. T (-)

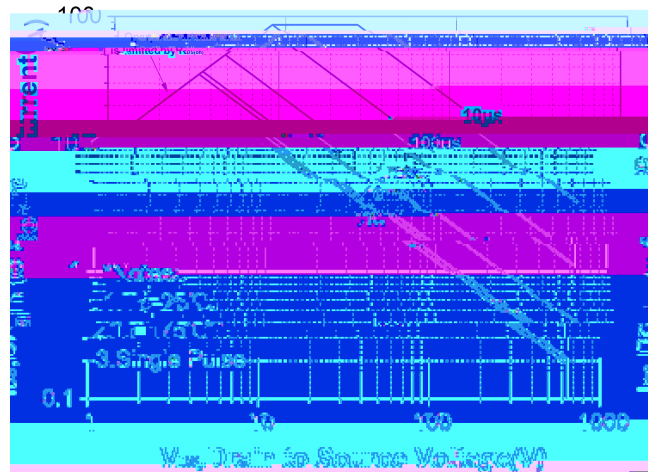

F 22. S

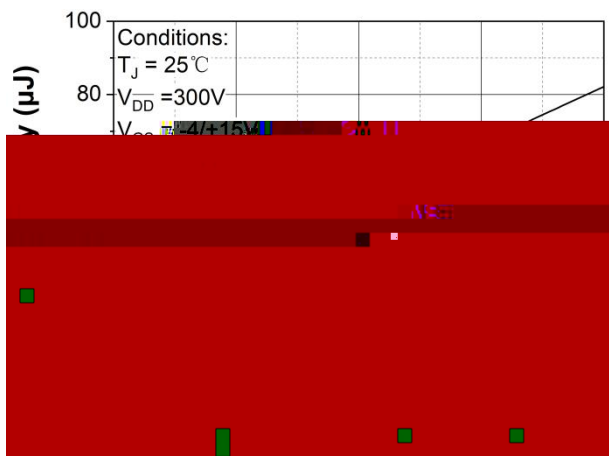

F 23. C I
(V_{DD} = 300)

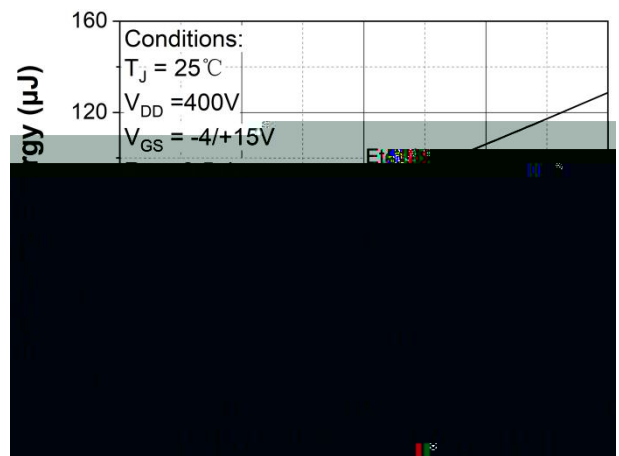

F 24. C
(V_{DD} = 400)

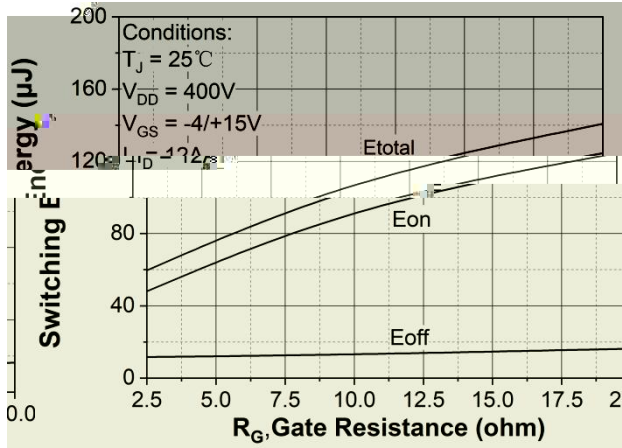

F 25. C . R_G ()

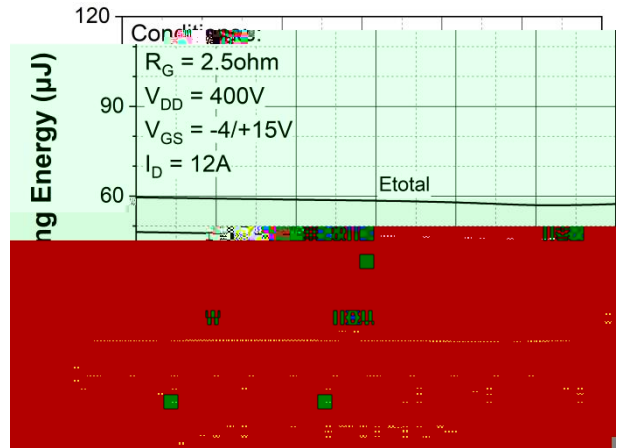

F 26. C .

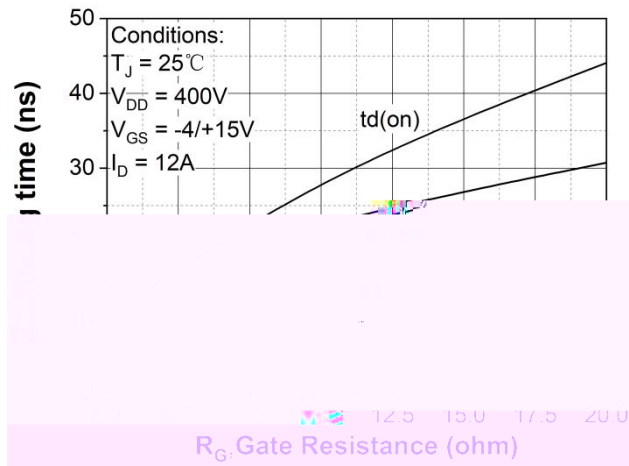

F 27. S . R_G ()

S3M090065LH



650V SiC Power MOSFET

5 Package drawing (TO-247-4L-C)

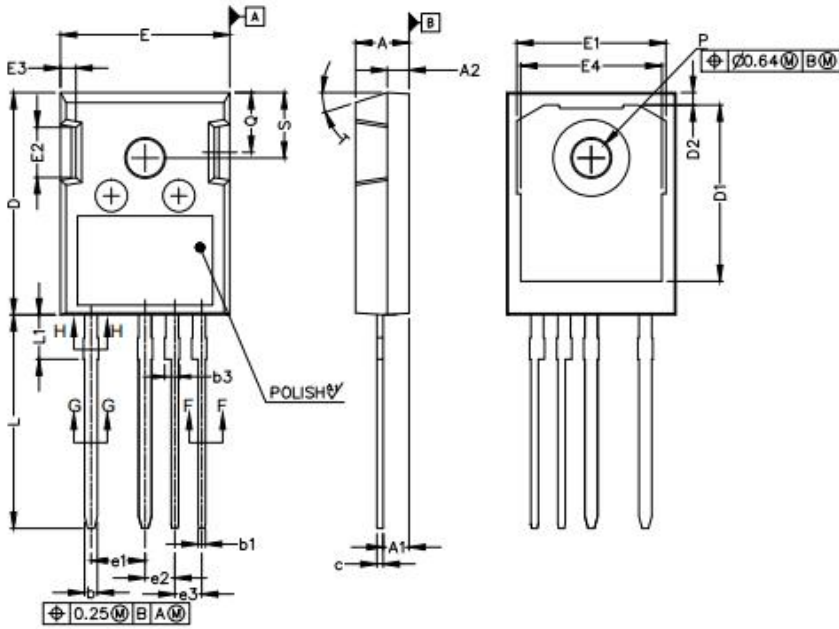

NOTE ;
 1. ALL METAL SURFACES: TIN PLATED, EXCEPT AREA OF CUT
 2. DIMENSIONING & TOLERANCING CONFORM TO
 3. ALL DIMENSIONS ARE IN MILLIMETER
 ANGLES ARE IN DEGREE

| MILLIMETERS | | |
|-------------|----------|-------|
| SYM | MIN | MAX |
| A | 4.83 | 5.21 |
| A1 | 2.29 | 2.54 |
| A2 | 1.90 | 2.16 |
| b | 1.10 | 1.30 |
| b1 | 0.65 | 0.80 |
| b2 | 1.10 | 1.25 |
| b3 | 1.34 | 1.44 |
| b4 | 0.65 | 0.80 |
| c | 0.55 | 0.68 |
| c1 | 0.55 | 0.65 |
| D | 20.80 | 21.10 |
| D1 | 16.15 | 17.65 |
| D2 | 0.95 | 1.35 |
| E | 15.70 | 16.13 |
| E1 | 13.10 | 14.15 |
| E2 | 4.32 | 5.10 |
| E3 | 1.00 | 2.60 |
| E4 | 12.38 | 13.50 |
| e1 | 5.08 BSC | |
| e2 | 2.79 BSC | |
| e3 | 2.54 BSC | |
| L | 19.72 | 20.32 |
| L1 | 3.97 | 4.37 |
| ø P | 3.51 | 3.70 |
| Q | 5.49 | 6.00 |
| S | 6.04 | 6.30 |

SECTION "F-F", "G-G"
 SCALE: NONE

PLATING

SECTION "H-H"
 SCALE: NONE

S3M009075LK

S3M090065LH



6. D .F
S .

7. E S
S ,S ' .

8. F (),
S , / , , : , , .